

Installation Instruction Condensers



Type Series TACW, TADW Thermofin Ammonia Condenser W-Form

1. Preliminary Notes	3
1.1 Fundamentals	3
1.2 Range of application	3
1.3 Standards and directives.....	4
2. Technical data	5
2.1. Design data.....	5
2.2 Application and intended use	5
2.3 Material data	5
2.4 Noise information	5
2.5 Unit key.....	6
2.6 Data on the type plate.....	6
3. Safety	7
3.1 General safety instructions.....	7
3.2 Safety instructions for the installation site.....	7
3.3 Safety instructions on the unit.....	8
3.4.2 Ammonia (NH ₃).....	9
4. Transport, storage, positioning, installation	10
4.1 General	10
4.2 Transport	10
4.2.1 Packing.....	11
4.3 Storage	11
4.4 Transport and positioning	12
4.5 Installation.....	13
4.6 Pipe connection	14
5. Fans and electric system	15
5.1 Connection and installation.....	15
5.2 Fans with EC motors.....	16
5.3 Fans with external rotor motors	16
5.4 Fans with standard motors or ATEX motors	16
5.5 Electrical switching and control mechanisms	17
5.5.1 Information of speed regulations	17
6. Commissioning, normal operation, maintenance, shutdown, disposal	18
6.1 Commissioning	18
6.1.1 Return to service after a longer period of standstill	18
6.2 Normal operation	18
6.2.1 Operation with water spraying system.....	19
6.3 Maintenance	19
6.3.1 Cleaning of the fins	20
6.3.2 Cleaning of the casings	21
6.4 Spare parts.....	21
6.5 Shutdown	21
6.6 Disposal.....	21
7. Inspection- and maintenance plan (recommendation)	22
8. Troubleshooting	23

1. Preliminary Notes

The purpose of assembly and operating manuals is to prevent dangers to persons and to the environment, which may be caused by a machine and by the work performed in connection with the unit, particularly during transport, assembly, commissioning and operation of the unit.

Therefore, all points of this manual must be carefully read and observed.



Warranty claims shall be excluded in case of errors and damages resulting from the fact that prescriptions of this operating manual have not been observed or in case of complaints resulting from the replacement of parts with non-original parts as well as from reconstructions or adjustments or modifications of the operating parameters or the functionality of the unit which have not been authorised explicitly by the manufacturer.

1.1 Fundamentals

The present assembly and operating manual refers to machines of the following type series:

→ **TACW, TADW: condenser ammonia, W-Form**

and to units with switching and control components installed – wired or unwired - or with deviations from the standard (X-...).

The corresponding technical data can be seen from the current catalogue, the machine data sheet and the type plate.



For the fan motors and controllers, the data given on their identification plates primarily apply.

1.2 Range of application

Condenser in refrigeration and air conditioning systems are used to allow for the emission of the liquefaction heat into the ambient air.

thermofin[®] condensers with stainless steel piping are by default suitable for the use with refrigerants of all fluid groups according to DIN EN 378-1 ed. 2008, whose pressure level does not exceed the specified maximum pressure under normal service conditions.

thermofin[®] condensers of the TADW series are suited for outdoor installation.



The indicated maximum pressure must neither be exceeded during operation nor during transport or storage or standstill!

1.3 Standards and directives

The manufacturer certifies the compliance with the standards according to the order-related declaration of incorporation and/or declaration of conformity included in the documents of the devices.

Furthermore, both the installation company and the operating company of the system should be familiar with the contents of the following standards, regulations and instructions:

- EU directive 97 / 23 / EC for pressure equipment (Pressure Equipment Directive)
- EU directive 2006 / 42 / EC for machinery (Machinery Directive)
- EU directive 2004 / 108 / EC (EMC directive)
- EU directive 2006 / 95 / EC (low voltage directive)
- EN 378; parts 1 to 4; "Refrigeration systems and heat pumps, safety and environmental requirements"; state: June 2008
- BGR 500 "Operation of Work Equipment"; chapt. 2.35: "Operation of refrigeration systems, heat pumps and cooling equipment"; applicable in the Federal Republic of Germany
- VDMA (German Federation of Machinery and Plant Construction) norm 24243 (08/2005) "Refrigerating machines and plants, tightness of refrigeration systems and heat pumps, leak detection and leak test"
- The present operating manual "thermofin[®] horizontal units"
- The labels attached to the unit, which contain instructions and information of the manufacturer
- Included order-related wiring diagram
- Wiring diagram for motor connection inside of the terminal boxes of the motors

The operator is obliged to observe – in addition to the regulations stated in this operating manual – all possible local particularities and / or applicable regulations.

2. Technical data

2.1. Design data

The design data of the unit are shown in the respective order documents and/or the unit data sheet. It can also be requested from factory by indicating the project or serial number (see type plate).

2.2 Application and intended use

The unit as incomplete machine according to Machinery Directive 2006/42/EC is intended for the installation in cooling systems. Despite meeting the requirements of intended use and handling the unit properly, residual risks cannot be completely prevented.

In principle, the unit is suitable for external installation.

The unit may only be used in places where the materials applied are not affected by the surrounding atmosphere or the medium flowing inside.

Any case of application differing from the one described above requires consultation with the manufacturer.

The manufacturer does not assume liability for any damages resulting from the non-compliance with these provisions.



The unit may not be put into operation until the conformity of the complete system has been declared!

2.3 Material data

pipes: made of stainless steel
The pipe systems are welded.

fins: made of aluminium, aluminium coated with epoxy resin, AlMg or copper

housing: galvanized and powder-coated steel, UV and corrosion resistant

2.4 Noise information

The sound pressure stated was determined by calculation according to DIN EN 13487 and indicates the average value of the sound pressure on the entire enveloping surface at the defined distance.

2.5 Unit key

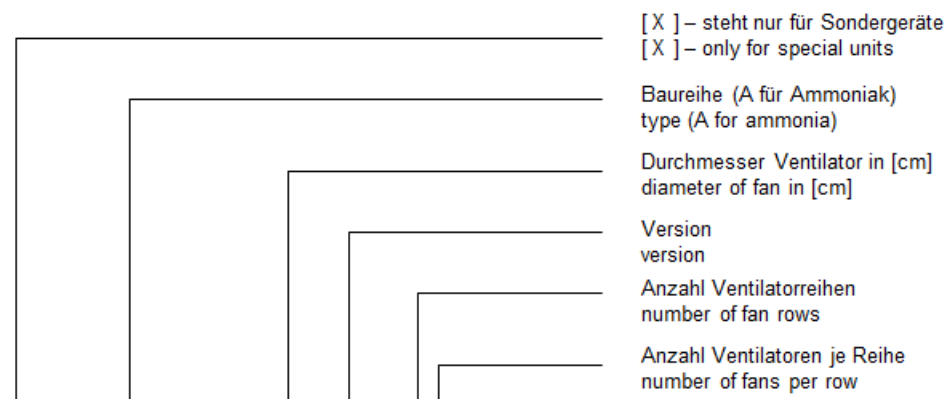

X – TACW – 080.1 – 24 – A – N – D5 – BC

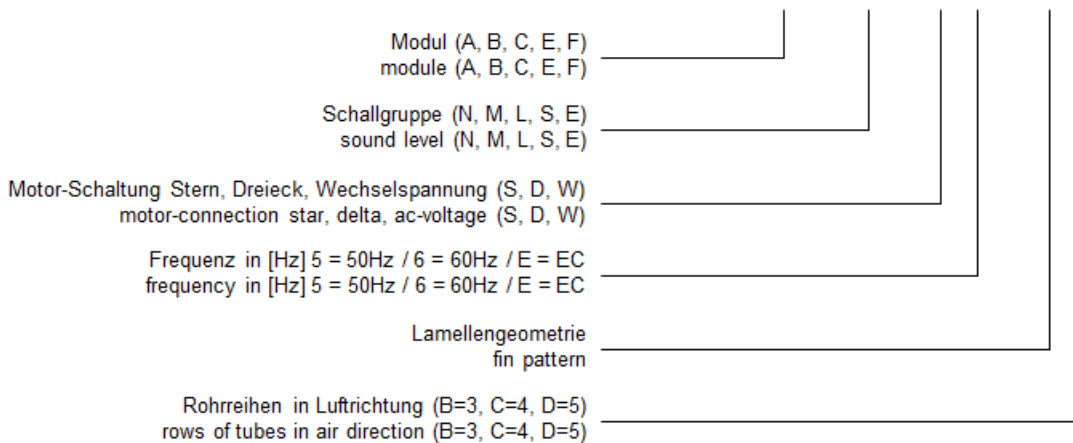

2.6 Data on the type plate

thermofin GmbH®		CE		thermofin®	
Am Windrad 1				heat exchangers - GERMANY	
D - 08468 Heinsdorfergrund					
Bezeichnung model					
Artikel-Nr. article-n°					
Projekt-Nr. project-n°					Geräte-Nr. unit-n°
Fertigungsjahr production year		Betriebsdruck max. working pressure max.	PS		bar
Rohrvolumen tube volume		Mediumtemp. zul. medium temp. all.	TS		°C
Leergewicht empty weight		Ventilator-temp. fan temp.			°C
Prüfüberdruck test pressure	PT	Prüfmedium test medium		Luft/air	
el. Anschlusswerte / connected load					
Ventilator(en) fan(s)		V		el. Heizung el. defrost	V
Δ / Y		kW			kW

- model description according to the unit key (see 2.5 unit key)
- article number of the manufacturer
- project or serial number
- month / year of manufacture
- tube volume of the heat exchanger
- empty weight of the unit
- test overpressure PT
- maximum working pressure PS
- allowed temperature range of the medium TS
- allowed temperature range of the fan
- pressure test medium of the heat exchanger
- connected loads

3. Safety

3.1 General safety instructions

The unit is state-of-the-art and reliable in operation. The machine may only be used in accordance with the specifications in the catalogue and the data given on the type plate. The unit may only be installed, commissioned and maintained by competent personnel. For installing the system, the installation conditions according to standard DIN EN 378 are to be observed. Furthermore, the applicable national rules and regulations, such as the water resources law, accident prevention regulations etc. are to be complied with. The company installing the system has to ensure the observance of all pressure and temperature limit values given on the type plate.



Compliance with the instructions of this operating manual does not release the plant operator from the obligation to install an appropriate warning system indicating each kind of malfunction immediately. In addition, emergency measures must be planned and prepared in order to prevent consequential damages in case of malfunctions.

3.2 Safety instructions for the installation site



The erection and installation conditions according to DIN EN 378 are to be observed. Pipes and fittings must be protected against misuse. Emergency facilities, such as lighting, venting, escape routes and the marking of which according to DIN EN 378 must be provided.



The machine must be lockable in case of leakage. Devices which are used for the discharge of released refrigerants must be operable from a safe location.



Refrigerant detectors and alarm systems which warn of hazardous concentrations have to comply with the assembly conditions of the DIN EN 378-3, chapt. 7 and 8.



No smoking at the installation site. Open fire is prohibited.

The fire extinguishing equipment must meet the requirements of DIN EN 378-3.

 There must be sufficient free space around the machine in order to prevent dangers to the machine and its connections and to ensure smooth execution of maintenance and repair work on the machine as well as on all fittings and components.

3.3 Safety instructions on the unit



Before performing installation, repair and maintenance works, the power supply must be interrupted at all circuits. An unauthorized and / or unintentional (automatic) restart must be prevented. Zero potential must be checked and - if applicable - ensured by the means of earthing or short circuiting. Adjacent energized parts need to be covered.



Do not touch the fin edges – risk of cuts!



Beware of hot gas lines – risk of burns!



Any unauthorized reconstructions or modifications affecting the functions or the safety of the unit are prohibited!



Any external forces acting on the equipment are to be avoided. In particular, equipment connections and manifolds may not be stressed (e.g. do not step on them).



Walking on the unit is only permitted with an appropriate antifaall guard!



It is not allowed to push objects through the safety guard of the fan or to put them in the circle of rotation of the fan blades.



Before performing welding and soldering work the unit must be depressurized!

During the performance of welding and soldering work, the cooling medium residues are exposed to high temperatures. In the process, highly toxic decomposition products like hydrogen chloride, hydrogen fluoride, or phosgene are developing.



In the event that refrigerants escape, use your personal protective equipment. Avoid any contact with the refrigerant; liquid refrigerants cause severe frostbite. In case of eye contact, seek medical advice immediately!



Beware of the lateral inspection openings or slewable fans! **Before opening the covers, the fans must be turned off and restart must be prevented!**



Do not climb on the pipelines and connections. Do not walk on the fans!



If the temperature difference between the ambient temperature and the medium inlet temperature exceeds 70K, the max. permitted temperature slew rate must be observed:

Start temperature	Temperature increase max.
$T_{\text{ambient}} < +10^{\circ}\text{C}$	1.5 K/min
$T_{\text{ambient}} \geq +10^{\circ}\text{C}$	3.0 K/min

3.4. Ammonia (NH₃)

The utilized refrigerant ammonia (NH₃) corresponds to the fluid group 1 according to DGRL (Pressure Equipment Directive) 97 / 23 EC or B2 according to DIN EN 378-1: 2008 and requires particular safety measures.

NH₃ is a toxic, pungent smelling gas. A health risk, though, only arises well above the odour threshold (warning effect of NH₃). Although NH₃ is inflammable as well as explosive, the danger of fire and explosion is relatively low due to the high ignition temperature, the narrow flammable range and the high affinity to humidity.



NH₃ causes agitation, dizziness, vomitus and cramps; with strong concentrations it also causes suffocation and pulmonary oedemas.



NH₃ has perilous to lethal effects from a concentration of 0.2 vol. %.



NH₃ has a strongly corrosive effect, especially on eyes and mucous membranes.

If NH₃ reaches the eyes, those effects cannot be stopped → disorientation.

Inhaled NH₃ causes an interruption of the respiratory airflow → panic.



NH₃-fluid on the skin causes frostbite and chemical burns.



NH₃ is very toxic to aquatic organisms and may under no circumstances enter drainage systems!



In case of leakages on the unit, it has to be locked and the emergency stop switch has to be pressed, **provided that this is possible without causing dangers**. During the elimination of the malfunction, attention has to be paid to residual NH₃ under boiling retardation.



NH₃-gas may not enter into neighbouring rooms, corridors or staircases.



Repair work is to be carried out on completely emptied plant components or segments only. Ensure proper ventilation. In case of works or sojourns in areas with high concentrations, use a respirator which is working independently of the ambient air!

The exposure to NH₃ requires the strict observation of the regulations and standards with regard to occupational safety. Particularly, measures according to the own safety have to be taken. This includes the wearing of safety equipment for the body according to the situation:



safety gloves



eye protection



respiratory protection (independent of ambient air)



personal protective equipment

Further and more detailed information and direction for use and first aid as well as provisions resulting therefrom are to be found in the corresponding safety data sheet.

4. Transport, storage, positioning, installation

4.1 General

The unit may only be installed, integrated in a refrigeration system, operated, maintained and repaired by qualified personnel of specialist companies according to the definitions of expertise from DIN EN 378.



During production and before delivery, each unit is subjected to comprehensive quality testing. The unit is provided in good order and condition. With delivery and before assembly, the unit must be checked for damages (damages in transit).

4.2 Transport



During transport, the unit must be handled with special care. In particular, always place the unit very carefully on the ground!



If indications on transport or storage are attached to the unit or the packaging, they must be absolutely observed!



Continuous mechanical loads due to bumps and potholes on the roadway can cause damages in transit.



Transportations by ship can cause damages in transit due to vibrations.



In case of critical transport routes (countries with bad streets or seaway) the mounting parts which could be set into vibration, especially fans, collectors, foot stands, must be disassembled and secured separately.



Units must be firmly fixed on the transport vehicle and protected against vibrations, punches and slipping!

4.2.1 Packing

Decisive factors for packing are the route of transport, the size of the equipment and the regulations applicable in the country of importation.



If not otherwise expressly agreed, the delivery is effected ex works in standard transport packaging at the discretion of thermofin®. According to contractual agreement, design and packaging are sufficient for the transport to the contractual agreed place of transfer of risk.



The purchaser is responsible for a possible further transport and the respective packaging.



In case of a packaging by external companies ordered by the purchaser or the customer, thermofin® cannot give any warranty for the design of the packaging and possible resulting transport damages. A safe design of the packaging should be agreed with thermofin®.

The pallets, crates and export boxes used for thermofin® units meet the requirements of the HPE and VDM standards (HPE – German Federal Association for Wooden Packages, Pallets and Export Packaging; VDM – Association of the German Furniture Industries). If required, they can be tailored to the standards of ISPM 15.

thermofin® transport packages are made of environmental friendly materials and they are suitable for recycling.

According to the German regulation on packaging, we are prepared to take back our packages if they are returned to us, delivered free to our location in Heinsdorfergrund.

Usually, thermofin® units are provided completely assembled, with the exception of the vibration dampers which are always delivered as loose parts (together with the unit). In the event that a unit is delivered disassembled – due to transportation or other reasons – it must be assembled on site according to the order-specific drawings enclosed.

Loading on road vehicles is performed in accordance with the VDI guideline 2700 "Securing of loads on road vehicles".



In case of groupage traffic and reloading, the responsibility lies with the forwarder.

4.3 Storage

If the units must be stored, the following points must be observed:



Store the units on a proper, dry place protected against environmental influences! Protect the fans against rain and condensation humidity (cold-warm)!



Store the units in an uprising, torsion-free and deflection-free manner!



Do not open the junctions; maintain the delivery pressure of the unit!



Do not stack more than two units! Respect the suitable packing size!

4.4 Transport and positioning



During transport, the machine must be handled with special care. In particular, always place the unit very carefully on the ground!

When transporting the equipment by crane, the lifting instructions attached to the machine or included in delivery are to be observed. Furthermore, the appropriate lifting accessories must be used. The sheet metal components of the housings may not be deformed by the belts. If it is not possible to ensure sufficient rope length (angle to the perpendicular of max. 30°, see drawing), a traverse must be used. The lifting accessories may only be attached to the suspension points intended for this purpose. Never use pipes or attachment parts for lifting.



The factory-provided transport weight (empty weight of the unit + transport packaging) is to be found on the corresponding label affixed to the transport packaging.

Transportgewicht / VPE

kg

transport weight / package



In case of using floor-borne vehicles is has to be paid heed to sufficient length of the load arms. Please pay attention to the position of the centre of gravity as well as to the information signs!

4.5 Installation

The suitability and the load bearing capacity of the foundations, brackets, machine frames etc. – provided by the customer – are not the responsibility of the equipment manufacturer. Within the calculation of the bearing load, additionally to the empty weight of the unit, also the weight of the tube content as well as possible additional weights such as snow, humidity and dirt must be taken into consideration.



It must be ensured that the building ground and supporting structure withstand the unit load permanently and that deformations or soil settlements are prevented.

It has to be ensured that the machine rests evenly on all contact points in a torsion-free and deflection-free manner. It must be fixed on the supporting structure by using appropriate fasteners. For this purpose, the mounting holes provided on the feet of the units shall be used.

The optional vibration dampers with anti-noise properties – included in delivery – are specifically designed for the respective unit. They are installed under the unit feet on site. The vibration dampers are only suited for absorbing vertical compressive forces. Therefore, each kind of shear or tractive force in transverse direction must be prevented. In the worst case, these forces may destroy the foot.



The installation in accumulated water (recesses, glycol collection trays...) may lead to rusting on the vibration dampers of the feet and may endanger the stability of the unit.

After installation and before commissioning all existing package parts and transport protection devices must be removed.



Please pay attention to sufficient distances to walls, sheathings or the like. The air flow must not be obstructed in any way. The dimensions as indicated are minimum dimensions!

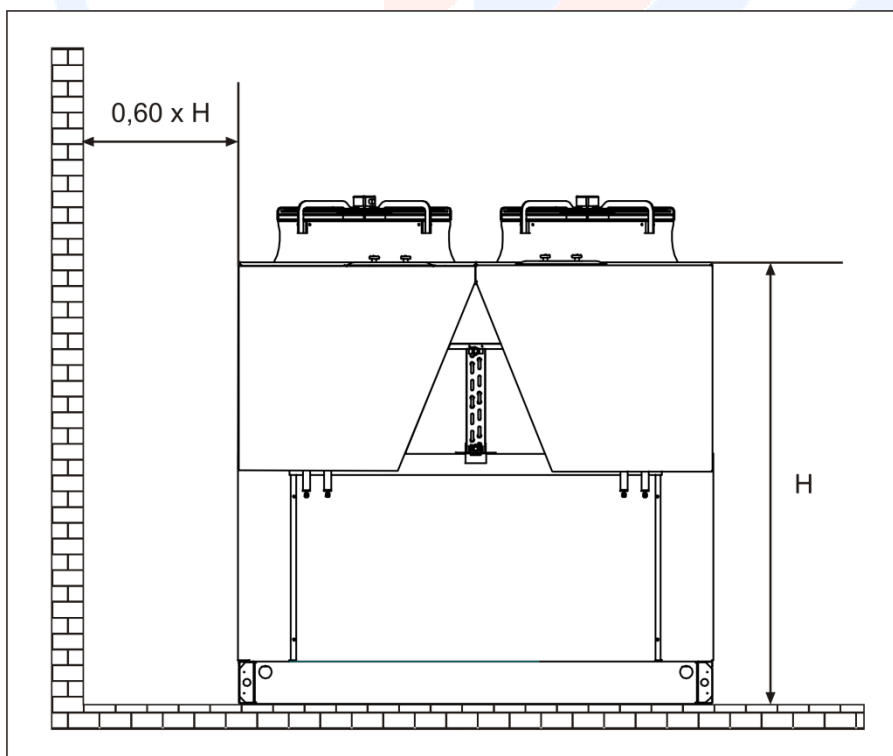

Concerning other variants than the ones mentioned in this documentation it is necessary to contact the manufacturer in advance.

4.6 Pipe connection



Soldered or welded devices or devices closed with counter flanges are delivered with an overpressure of approx. 1 bar (cleaned and dried air) (according to the regulation for the transportation of hazardous material ADR 1.1.3.2 c).



Before removing the closing caps or the counter flanges it must be verified that the overpressure is present. A depressurized device indicates a leakage (Damage in transit! Leak test!).



In case of depressurized devices, the manufacturer must be consulted immediately. Before the assembly, the transport pressure must be released and the closing caps must be removed.

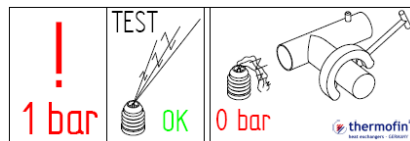

Pipe connections are to be designed in such a way that any force, stress and vibration effects on the machine are prevented.

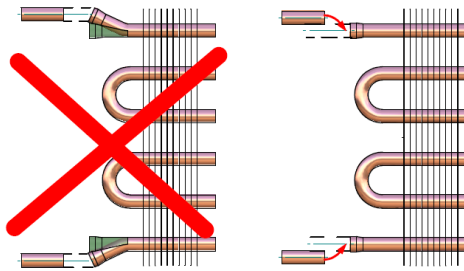

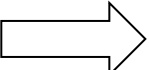
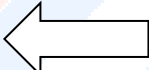
The inlet  and outlet  must be observed according to the marking.

5. Fans and electric system

5.1 Connection and installation



The electrical **connection** of the fans and/or the electrical accessories, if existent, must be performed in accordance with the applicable national regulations and the provisions of the local energy supply company!



The electrical installation may only be carried out by **qualified personnel**. The local regulations must be observed.



A suitable **all-pole separator**, which is not included in thermofin[®]'s scope of supply, must be integrated in the installation.

In order to prevent an unintended start, the deactivation system must be possible to protect it in deenergised (deactivated) condition!



Wiring may only be performed in accordance with the circuit and **wiring diagrams** provided.



The existing **strain-relief devices** must always be used.



The **direction of rotation** of the fans must be observed!



The **thermal motor protection** is either already integrated in the electrical feed line of the fans or shall be integrated in the electrical control system by the company installing the system (see wiring diagram of the fans). It must be ensured that motors with released thermal protector cannot be activated before the winding is cooled down. Otherwise, the warranty claim expires!



Observe the information given on the type plate! The capacity and the power consumption of the fans directly depends on the ambient temperature (air density) and can be, in case of cold temperatures, above the information given on the type plate.



With the installation it must be observed that humidity can condensate in cold rooms and that dripping water can be formed in the sockets! If the fans are provided with **condensate water holes**, respectively the lower ones shall be opened! A non-compliance leads to the expiration of warranty claims!



In circumstances, in order to prevent an entrance of **condensation**, fans in cold environment should be hold on temperature during standstill using a standstill heater. Thermal motor protection required!



In case of humidity entry due to spraying, sprinkling or jet water, a **standstill heater** is necessary. A thermal motor protection is obligatory!



An icing of the impellers and fan nozzles must be prevented! **Ice residues** on impellers lead to imbalances and damages to the fan! A noncompliance leads to the expiration of warranty claims!



For all works on fans and motors as well as cleaning works between the fans and the heat exchanger coil (inspection cover), the power supply must be deactivated and **protected against restart!**



After finishing repair and maintenance works, ensure that no objects remain in fan proximity since they can cause errors and damages to the fan or heat exchanger after restart. After disassembling the fans and their reinstallation, the **free running** must be checked.



In case of longer **down times** of the system, e.g. storage, the fans must be operated for approx. 3 to 4 hours per month in order to evaporate condensations and to move the bearings.



For the installation of the unit or subsequent installations assure **compliance with the degree of protection**. In particular the sealing of the cable glands and terminal covers must be checked for intactness and correct fitting.

For further information on the connection of fans, controllers, standstill heaters and thermal motor protection systems, please refer to customer information FB.02.07 provided in the download area of our website or which we can send to you upon request.

5.2 Fans with EC motors



In some circumstances, EC fans remain energised in deactivated condition on power-side and are switched on control side.



Depending on the used fan type, the control can be effected via different BUS-systems, 0-10V-signal or 4-20mA. Order-specific documents as well as the provided fan documentation and/or wiring and connection plan, must be observed.

5.3 Fans with external rotor motors

All serial units delivered by thermofin[®], are equipped with maintenance-free, energy-saving fans of renowned manufacturers. However, fans should be checked regularly according to maintenance plan (point 7) for function, bearing noises, free running and imbalances. Furthermore, terminal covers must be checked for tight fitting and sealing. Since the bearings are ex-works maintenance free and lubricated for lifetime, an individual check is not required. **In case of longer down times of the system, e.g. storage, the fans must be operated for approx. 3 to 4 hours per month in order to evaporate condensation and to move the bearings.**

5.4 Fans with standard motors or ATEX motors

Maintenance measures and maintenance intervals must be effected according to the information of the motor manufacturer. If there is no information of the motor manufacturer, proceed according to inspection and maintenance plan (chapter 7). Lower closed condensate holes should be opened minimum twice per year. Depending on application, the bearings and/or the bearing lubricant have a limited lifetime and must be checked and replaced according to maintenance plan (chapter 7). In case of a bearing replacement, also the shaft seals (Stefa rings) must be replaced. Impellers must be regularly checked for imbalance, tight fitting, soiling and corrosion.

In case of longer down times of the system, e.g. storage, the fans must be operated for approx. 3 to 4 hours per month in order to evaporate condensation and to move the bearings.



All components that were removed, loosened or disassembled for cleaning or inspection purposes must be properly reinstalled after work completion. They must also be checked for correct functioning!

Further preventive measures are in the discretion of the system operator or the company installing the system.

5.5 Electrical switching and control mechanisms

thermofin[®] offers different variant options with maintenance switch or motor protection switch, phase angle control or frequency regulators as well as combinations thereof – on demand, fully pre-wired. Here, a function test should be performed at regular intervals. The cables and components must be subjected to a visual inspection; the terminals must be checked for tight fitting. In addition, it must be checked whether the set parameters are still in line with the system configuration.



All components that were removed, loosened or disassembled for cleaning or inspection purposes must be properly reinstalled after work completion. They must also be checked for correct functioning!

5.5.1 Information of speed regulations



In case of regulating the fans with frequency converter, the use of an all-pole sinus filter between converter and fans is mandatory! In case of non-observance the warranty expires!



In case of a phase angle regulation, electromagnetic motor noises (buzzing) are possible in the lower speed range. In sensitive environments, a sound filter should be added.



For dimensioning of the phase angle regulation, a possible control-related current increase should be taken into consideration. In case of doubt, the manufacturer should be contacted.



Pressure and temperature sensors must be properly installed and connected. Tightness and a good heat transfer must be ensured. Shield signal cables and lay them separately from the load cables!

6. Commissioning, normal operation, maintenance, shutdown, disposal

6.1 Commissioning

Before starting operation, the system's readiness for operation must be verified according to the following points:

1. Has the unit been properly installed and fixed in accordance with the instructions of the present manual?
2. Have all fluid-carrying lines been connected and checked for tightness? Are the shut-off devices open?
3. Is the flow direction correct?
4. Are all cables properly installed and completely connected? Has cabling been done according to the wiring diagrams provided?
5. Has the electrical protective installation been checked for proper functioning?
6. Have all bolted connections (e.g. fans, cable entries), fastenings, electrical connections etc. been checked for tight fit?
7. Are all terminal boxes and cable entries firmly closed and tight?
8. Do the fans rotate freely and in the right direction?

During start of operation the following measures shall be taken:

1. Check and, if necessary, adjust the direction of rotation of the fans.
2. Measure the current consumption of the fans and check for compliance with the type plate data.
3. Adjust the electrical switching and control devices and check for correct functioning (see the specific operating instructions of the respective control device).
4. Check the switch point settings of the safety equipment.

6.1.1 Return to service after a longer period of standstill

If the unit is intended to be put into operation again after being shut down and standing still for a longer period of time, the following points must be checked in addition to those mentioned under "6.1 Commissioning":

1. Visual inspection of the heat exchanger coil, check for fouling and damages
2. Leak test of the heat exchanger coil
3. Visual inspection and functional test of the fans; check for free running, check the terminal boxes for tightness, check for corrosion and noise (bearings)
4. Check all pipe connections (including pipe clips), electrical components, housings and attachment parts for tight fit

6.2 Normal operation

For running the unit, the entire plant including the electrical system must be operating.

The unit is integrated in the cooling circuit by opening the corresponding shut-off valves.

It is turned on by activating the electrical system.

After reaching the system-specific operating point the unit is ready for operation.

In case of operating conditions which differ from those stated in the quotation, the manufacturer must be consulted.

6.2.1 Operation with water spraying system

In some cases, the unit is equipped with a pipe system for the operation with water spraying system. It is intended to cover peak loads. It is recommended to a limited extend, especially for the operation with water of unknown quality.

The following must be observed:

Original water: - PH value 6.5 – 8
 - Electrical conductivity < 1200µS/cm
 - Chloride < 75mg/l (ppm)
 - Sulfate < 250mg/l (ppm)

Hardness: < 2.0° dH

Spraying pressure: according to case of application, see data sheet

These information refer to an operating time of not more than 200 hours per year.



Depending on the case of application, the maximum possible operating times can variate.



Strong risk of corrosion when using water with non-permitted water quality!



In case of doubt, the manufacturer should be contacted before commissioning of the spraying system.

The piping for the water spraying system must be installed with an incline of approx. 2°!
It must be ensured that the pipes are drained if the spraying system is out of operation (danger of bursting with frost)!

Also observe the VDMA leaflet “Advices and recommendations for the operation and maintenance of evaporation coolers” as well as the guideline „VDMA-Einheitsblatt 24649 „Advices and recommendations for effective and safe operation of evaporation coolers“.

Also observe local and national recommendations, regulations or laws for a safe operation and maintenance of evaporation coolers.

6.3 Maintenance

The manufacturer recommends performing particular maintenance works at regular intervals. The type and frequency of the measures strongly depend on the respective installation site of the heat exchanger.

6.3.1 Cleaning of the fins

Depending on the installation site, mode of operation and the season, the heat exchanger fins are subject to fouling (varying degree). As this directly affects the performance and thus the current consumption of the unit, the cleanliness of the finned coil must always be ensured.

Dry cleaning: with a broom or a soft brush from the outside towards the fins or from the inside towards the outside by using compressed air – opposite to the direction of the air flow of the fans.



Switch off the unit (regarding refrigeration and electricity)!

Wet cleaning: with a water jet from the inside towards the outside and opposite to the direction of the air flow of the fans; and from top to bottom. The jet of the cleaning device must be vertical to the heat exchanger coil (max. deviation $\pm 5^\circ$), in order to prevent fin deformations.

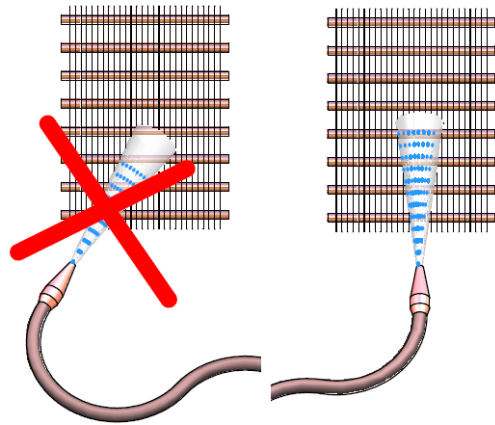

Switch off the unit (regarding refrigeration and electricity)!



Use of high pressure and steam pressure washers up to 80bar max.



Electrical components may not be exposed to the water jet!



When using cleaning agents, the compatibility of materials must be ensured. Never use aggressive or corrosive cleaning agents! In case of doubt, consult the manufacturer. Application rules of the manufacturer with regard to handling and use, especially dosage, reaction time and after-treatment, must be strictly respected.



Mechanical cleaning with hard objects, such as steel brushes or screwdrivers may destroy the heat exchanger, therefore it is not permitted.

6.3.2 Cleaning of the casings

thermofin® heat exchanger casings have smooth surfaces which are equipped with a hygienic, corrosion-resistant powder coating which makes the cleaning of the devices very easy. The devices should be cleaned with water or a mild soap leach.

In order to comply with special hygienic requirements, devices with a casing made of stainless steel must be used where necessary.



When using cleaning agents, please observe the compatibility of materials. Never use aggressive or corrosive cleaning agents. If necessary, contact the manufacturer or the supplier of the cleaning agent. Application rules of the manufacturer with regard to handling and use, especially dosage, reaction time and after-treatment, must be strictly respected.



Under no circumstances use sharp-edged tools or scrapers!

Potentially existing dust filters are removable and can be cleaned by means of a vacuum cleaner or under running water.

6.4 Spare parts

After-sales services shall be performed by the responsible specialist company. Spare parts are stated in the spare parts list enclosed in the annex or in the specified drawing. They can also be requested from the manufacturer by indicating the device name and the project number on the type plate.

Only use original spare parts for the replacement of equipment components.

6.5 Shutdown

The units are part of a cooling system. Unit shutdown and return to service must meet the system-dependent requirements as well as the requirements of the operating manual of the equipment manufacturer and of the applicable standards and accident prevention regulations (see also chapter "Applied standards and directives"). The shutdown is effected by closing the fluid-bearing tubes and by switching off the electrical system.



The following applies for all units: Exceeding the maximum pressure must be prevented!



In case of longer standstill periods of the system, the fans should be operated for approx. 3 to 4 hours per month.

6.6 Disposal



Empty the system properly in a technically correct manner; properly dispose of the working fluid. No emissions in the environment!



Oil residuals must not reach the ground and must be disposed of with the special waste.



Bring the emptied unit to recycling.

7. Inspection- and maintenance plan (recommendation)

Depending on type, installation and environmental conditions, the heat exchangers are subject to different signs of wear and contamination during operation. In order to ensure an excellent operation and a maximum operational reliability, periodical maintenance measures must be executed. Maintenance and repair measures as well as recurring inspections should comply with the valid standards and statutory provisions, e.g. EN 378, 842/2006/EC, VDMA 24243, 2006/42/EC, 97/23/EC and/or local factory standards or regulations applicable at installation site. The following table can serve as recommendation.

inspection point	main topic	interval	actions
general visual inspection	general condition corrosion pollution	monthly	initiate corresponding maintenance measures
heat exchanger coil	pollution tightness	quarterly	cleaning repair leakage if necessary
pipng connections	tight fit tightness* deformations	quarterly	ensure tight fitting, repair leakage if necessary determine the cause, contact manufacturer if necessary
connections and fixations	tight fit tightness deformations	quarterly	ensure tight fitting, repair leakage if necessary determine the cause, contact manufacturer if necessary
shut-off-devices, valves, security modules	operation accessibility	quarterly	replace damaged parts ensure accessibility
fans, motors, impellers	function free running noises pollution	quarterly	remove obstacles and pollutions replace bearing if possible replace damaged fans
	closed condensate holes	half-yearly	open and drain condensate
switching devices	function accessibility	quarterly	replace bearing if possible ensure accessibility
junction boxes, strain reliefs, cable fittings	tight fit tightness operation	quarterly	replace damaged parts retighten loosened screw connections
safety equipment and devices emergency signals alarm systems	operation	yearly	replace damaged parts
pressure relief equipment	tightness visual inspection	yearly	replace damaged parts

8. Troubleshooting

incident	cause	action
drop of cooling capacity, condensation temperature too high condensation pressure too high	fins soiled	clean the coil
	fan out of work	check power supply
		measure power consumption
		check appropriating terminal box
	check thermostat relay	
vibrations	fan out of balance	check impellers for damages, possibly exchange fan
noises	impellers and motors do not rotate freely	remove any existing obstacle
	bearing damage on motor	replace fan
leakage	damaged and leaking core tube	locate and repair core tube, possibly giving up
	leaking bend or connector	repair or exchange the part

Contact

Address: thermofin GmbH
Am Windrad 1
08468 Heinsdorfergrund
Germany

Phone: +49 3765 3800-0
Fax: +49 3765 3800-8038
E-mail: info@thermofin.de
Internet: www.thermofin.de

